

Perspective View

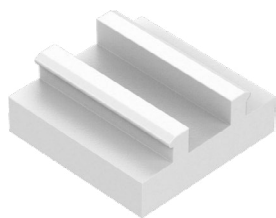

Assembled End View

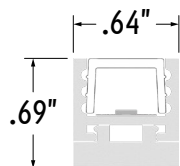

UNASSEMBLED APPLICATIONS

1. Measure area where luminaire will be installed. Use a laser line to create a reference line along installation area, ensuring consistent alignment of mounting clips. Mark location where each mounting clip will be installed along reference line.

2. Use 1 mounting clip every 2', rounded up.

Note: For vertical applications, use a stopper at the bottom to prevent fixture from sliding.

Example 1: Individual run of 8'.

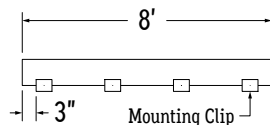

Example 2: Continuous run of 21' (8' + 8' + 5').

Apply the 1 mounting clip per 2' rule to each luminaire segment.

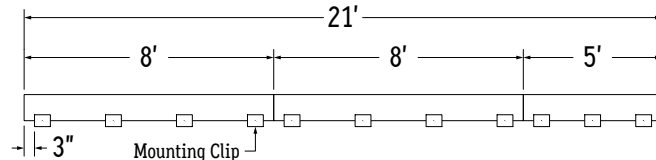

3. Snap mounting clips into extrusions according to the diagram above that best suits your application.

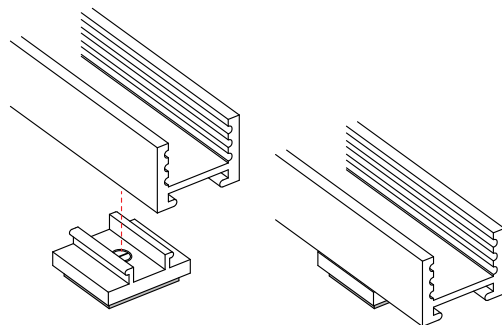

ASSEMBLED APPLICATIONS

1. Measure area where luminaire will be installed. Use a laser line to create a reference line along installation area, ensuring consistent alignment of mounting clips. Mark location where each mounting clip will be installed along reference line.

2. Use 1 mounting clip every 2', rounded up.

Note: For vertical applications, use a stopper at the bottom to prevent fixture from sliding.

Example 1: Individual run of 8'.

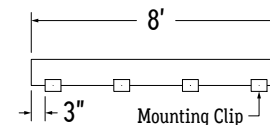

Example 2: Continuous run of 21' (8' + 8' + 5').

Apply the 1 mounting clip per 2' rule to each luminaire segment.

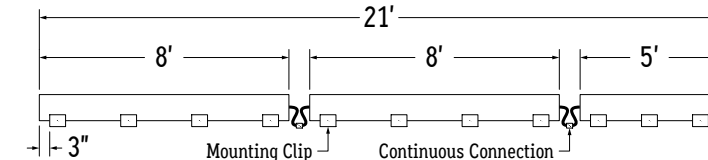

4. Place extrusions with magnet mounting clips installed onto a ferromagnetic material, ensuring the extrusions are properly aligned.

Note: The surface material must be capable of holding the weight of the luminaires.