

Perspective View

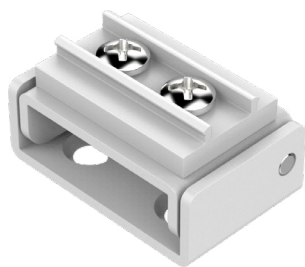

Assembled End Views

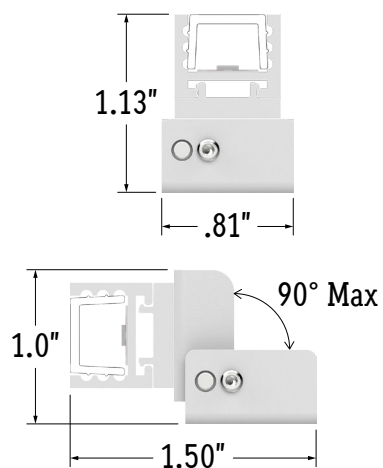

UNASSEMBLED APPLICATIONS

1. Measure area where luminaire will be installed. Use a laser line to create a reference line along installation area, ensuring consistent alignment of mounting clips. Mark location where each mounting clip will be installed along reference line.

2. Use 1 mounting clip every 2', rounded up.

Note: For vertical applications, use a stopper at the bottom to prevent fixture from sliding.

Example 1: Individual run of 8'.

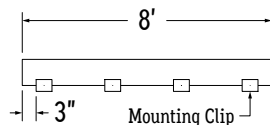

Example 2: Continuous run of 21' (8' + 8' + 5').

Use a mounting clip at the joint between luminaire segments.

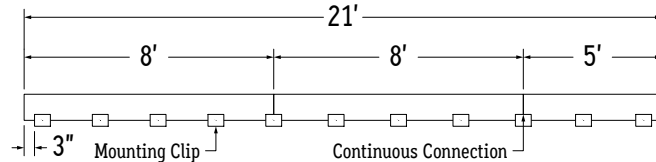

3. Loosen set screw with included Allen Wrench and tilt top to reveal mounting holes.

Note: Do not remove Set Screw.

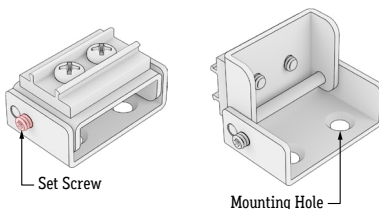

4. Lay mounting clips along reference line and pre-drill using an appropriate drill bit for surface and screw size. **Recommended:** 8/32 x 1" screw.

Note: Allow 0.25" clearance for lateral expansion of assembled mounting clips. Only install mounting clips on flat, even surfaces.

ASSEMBLED APPLICATIONS

1. Measure area where luminaire will be installed. Use a laser line to create a reference line along installation area, ensuring consistent alignment of mounting clips. Mark location where each mounting clip will be installed along reference line.

2. Use 1 mounting clip every 2', rounded up.

Note: For vertical applications, use a stopper at the bottom to prevent fixture from sliding.

Example 1: Individual run of 8'.

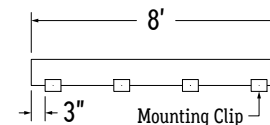

Example 2: Continuous run of 21' (8' + 8' + 5').

Apply the 1 mounting clip per 2' rule to each luminaire segment.

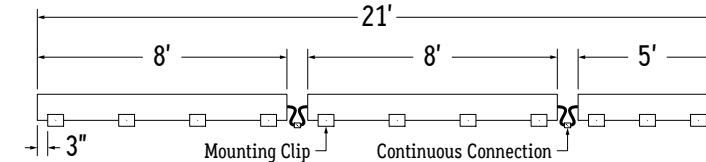

5. Screw mounting clips to surface.

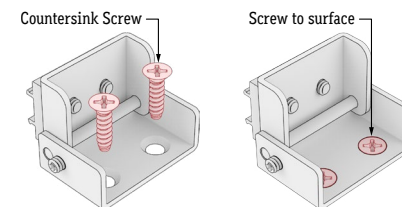

6. Adjust mounting clip to desired angle, then tighten set screw to lock in place.

Tip: Use an angle finder or create a jig to ensure accuracy of angles.

